

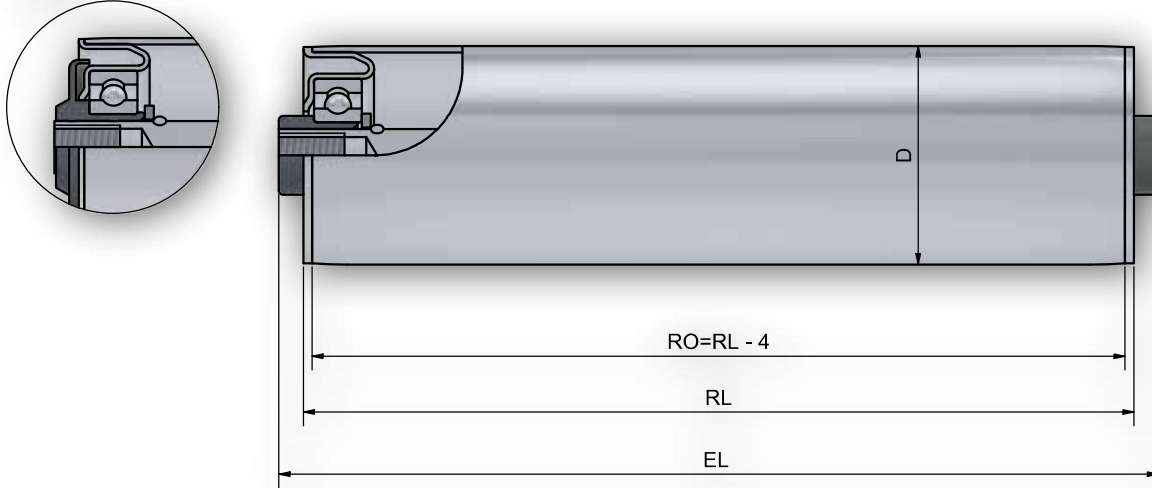





# Roller 250 / 251

Typ 251



## Shaft dimensions

Order Specification		A...M...	A...AGM...	A...IGM...	A...glatt	A...SW...	A...FA...
Shaft-Ø	EL=						
8	RL+	23			10		10
10	RL+	22	10	10	10	10	10
S11	RL+				10		10
12	RL+	24	10	10	10	10	10
14	RL+	26	10	10	10	10	10
15	RL+		10	10		10	
17	RL+	26		10		10	

## Tube- and Shaft Combination

Tube dia.	A8	A10	S11	A12	A14	A15	A17
40 x 1,5				x			
50 x 1,5	x	x	x	x	x	x	x
50 x 2	x	x	x	x	x	x	x
60 x 2	x	x	x	x	x	x	x
60 x 3		x	x	x	x	x	x
80 x 2				x	x	x	x
80 x 3				x	x	x	x

# Roller 250 / 251

## Bearing Type

## Steel housing with Precision Ball Bearing

Type of Bearing	Ball Bearings (Series 6001,6003,6202) DIN 625 available in 2RS, ZZ Standard Series 6202ZZ - plastic distance bushings to get the shaft diameters
Load Capacity/Roller	2.400N (depending upon the load limit of tube and shaft) See fold-out cover
Max. Speed	1,2 m/s
Range of Temperature Celcius	-5 to +60 C
Optional	Type 251 with additional shelter
Note	For use as driven roller. Tube dia. 40 mm only with Shaft dia. D=12 mm (Ending flat and FA not available). Shaft dia. 15 mm und 17 mm without distance bush. Type 251 for shaft 17 mm not available. With special greasing even for use in Deep Freeze Areas (-28°C).

## Order Example

<b>Type</b>	<b>250 ZZ - 50x1,5 STI A12 IGM 8x15 EL=500mm</b>
Bearing Type.....	ZZ
Ball bearing sealing .....	ZZ
Tube-Ø and wall thickness .....	50x1,5
Tube quality.....	STI
Shaft-Ø.....	A12
Shaft Ends.....	IGM 8x15
Installation length .....	EL=500mm